

Fine Quality

Precision Engineered



Advanced Design

Excellent Prices

## Contents

Fittings Numbering System.....	B2
Stainless Steel Push-In Fittings List Price.....	B3 - B4
Stainless Steel Push-In Fittings Specifications.....	B5
Stainless Steel Fittings Dimensions.....	B6 - B8
Compression & Barb Fittings Numbering System.....	B9
Compression Fittings Specifications.....	B9
Compression Fittings List Price.....	B10 - B11
Barb Compression Fittings List Price.....	B12
Barb Compression Fittings Specifications.....	B12

Ordering Part No. =  
(e.g., BCS 1/4 N3/8 W)

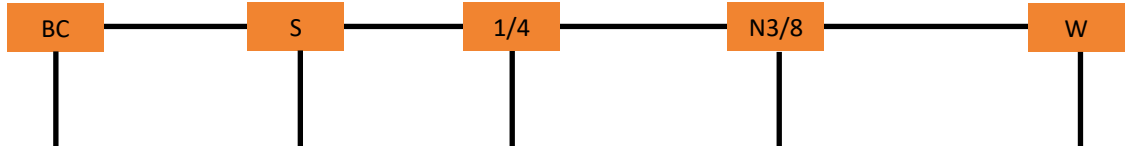

Fitting Name	
Branch Tee	BT
Bulkhead Connector	BC
Bulkhead Union	BU
Cartridge Fitting	CF
Elbow Union	EU
Female Connector	FC
Female Elbow	FE
Hex Bushing	HB
Male Connector	MC
Male Elbow	ME
Plug In Elbow	PE
Reducing Union	RU
Run Tee	RT
Straight Union	SU
Tee Union	TU
Tube Adaptor	TA
Tube Connector	TC
Tube Reducer	TR

Material / Type	
316 Stainless Steel	S

Tube OD	
Inches	1/8
	5/32
	3/16
	1/4
	5/16
	3/8
mm	4
	6
	8
	10
	12
	14
16	

Thread Size / Stem / Tube	
N = NPT	N1/8
	N1/4
	N3/8
	N1/2
R = PT (British Standard Pipe Taper Thread)	R1/8
	R1/4
	R3/8
	R1/2
G = PP (British Standard Parallel Pipe Thread)	G1/8
	G1/4
	G3/8
	G1/2
U = Universal Threads (fits NPT, R, & G)	U1/8
	U1/4
	U3/8
	U1/2
Machine Thread	10-32
	M5
	M6
Stem Size	1/8-1/2"
	4-12mm

Stainless Steel Fitting Options—Tube Gripping/Releasing Mechanism	
Collet style with Stainless Steel Release Button	(leave blank)
Gripper Style with Stainless Steel Release Button	W

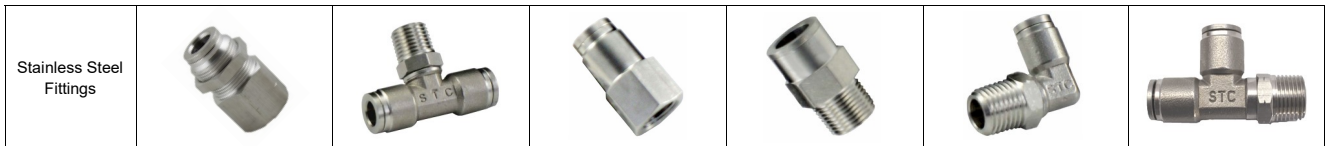

Model		Bulkhead Connector		Branch Tee (Swivel)		Female Connector		Male Connector		Male Elbow (Swivel)		Run Tee (Swivel)	
		BCS		BTS		FCS		MCS		MES		RTS	
Tube OD	Thread	Part No.	Unit Price	Part No.	Unit Price	Part No.	Unit Price	Part No.	Unit Price	Part No.	Unit Price	Part No.	Unit Price
1/8"	10-32	BCS 1/8 10-32 W	\$26.89	BTS 1/8 10-32 W	\$27.86	FCS 1/8 10-32 W	\$11.57	MCS 1/8 10-32 W	\$9.92	MES 1/8 10-32 W	\$19.73	RTS 1/8 10-32 W	\$27.86
1/8"	NPT1/8	BCS 1/8 N1/8 W	\$26.89	BTS 1/8 N1/8 W	\$27.86	FCS 1/8 N1/8 W	\$11.57	MCS 1/8 N1/8 W	\$9.92	MES 1/8 N1/8 W	\$19.73	RTS 1/8 N1/8 W	\$27.86
1/8"	NPT1/4	BCS 1/8 N1/4 W	\$29.76	BTS 1/8 N1/4 W	\$29.28	FCS 1/8 N1/4 W	\$16.24	MCS 1/8 N1/4 W	\$10.41	MES 1/8 N1/4 W	\$23.70	RTS 1/8 N1/4 W	\$29.28
5/32"	10-32	BCS 5/32 10-32 W	\$26.89	BTS 5/32 10-32 W	\$27.86	FCS 5/32 10-32 W	\$11.57	MCS 5/32 10-32 W	\$9.92	MES 5/32 10-32 W	\$19.72	RTS 5/32 10-32 W	\$27.86
5/32"	NPT1/8	BCS 5/32 N1/8 W	\$26.89	BTS 5/32 N1/8 W	\$27.86	FCS 5/32 N1/8 W	\$11.57	MCS 5/32 N1/8 W	\$9.92	MES 5/32 N1/8 W	\$19.72	RTS 5/32 N1/8 W	\$27.86
5/32"	NPT1/4	BCS 5/32 N1/4 W	\$29.76	BTS 5/32 N1/4 W	\$30.72	FCS 5/32 N1/4 W	\$15.45	MCS 5/32 N1/4 W	\$9.92	MES 5/32 N1/4 W	\$19.72	RTS 5/32 N1/4 W	\$30.72
1/4"	10-32	BCS 1/4 10-32 W	\$30.51	BTS 1/4 10-32 W	\$27.86	FCS 1/4 10-32 W	\$11.57	MCS 1/4 10-32 W	\$9.92	MES 1/4 10-32 W	\$20.99	RTS 1/4 10-32 W	\$27.86
1/4"	NPT1/4	BCS 1/4 N1/4 W	\$30.51	BTS 1/4 N1/4 W	\$27.86	FCS 1/4 N1/4 W	\$11.57	MCS 1/4 N1/4 W	\$9.92	MES 1/4 N1/4 W	\$21.01	RTS 1/4 N1/4 W	\$27.86
1/4"	NPT1/8	BCS 1/4 N1/8 W	\$30.51	BTS 1/4 N1/8 W	\$32.04	FCS 1/4 N1/8 W	\$11.57	MCS 1/4 N1/8 W	\$9.92	MES 1/4 N1/8 W	\$22.70	RTS 1/4 N1/8 W	\$32.04
1/4"	NPT3/8	BCS 1/4 N3/8 W	\$31.93	BTS 1/4 N3/8 W	\$36.54	FCS 1/4 N3/8 W	\$12.46	MCS 1/4 N3/8 W	\$10.81	MES 1/4 N3/8 W	\$23.62	RTS 1/4 N3/8 W	\$36.54
5/16"	NPT1/8	BCS 5/16 N1/8 W	\$31.93	BTS 5/16 N1/8 W	\$35.03	FCS 5/16 N1/8 W	\$16.33	MCS 5/16 N1/8 W	\$13.19	MES 5/16 N1/8 W	\$24.02	RTS 5/16 N1/8 W	\$35.03
5/16"	NPT1/4	BCS 5/16 N1/4 W	\$31.93	BTS 5/16 N1/4 W	\$35.03	FCS 5/16 N1/4 W	\$16.33	MCS 5/16 N1/4 W	\$13.19	MES 5/16 N1/4 W	\$24.80	RTS 5/16 N1/4 W	\$35.03
5/16"	NPT3/8	BCS 5/16 N3/8 W	\$31.93	BTS 5/16 N3/8 W	\$40.26	FCS 5/16 N3/8 W	\$16.33	MCS 5/16 N3/8 W	\$13.94	MES 5/16 N3/8 W	\$25.36	RTS 5/16 N3/8 W	\$40.26
5/16"	NPT 1/2	BCS 5/16 N1/2 W	\$33.37	BTS 5/16 N1/2 W	\$41.70	FCS 5/16 N1/2 W	\$19.19	MCS 5/16 N1/2 W	\$15.08	MES 5/16 N1/2 W	\$30.59	RTS 5/16 N1/2 W	\$42.63
3/8"	NPT 1/8	BCS 3/8 N1/8 W	\$35.56	BTS 3/8 N1/8 W	\$40.26	FCS 3/8 N1/8 W	\$19.82	MCS 3/8 N1/8 W	\$13.19	MES 3/8 N1/8 W	\$26.27	RTS 3/8 N1/8 W	\$40.26
3/8"	NPT1/4	BCS 3/8 N1/4 W	\$35.56	BTS 3/8 N1/4 W	\$40.26	FCS 3/8 N1/4 W	\$19.82	MCS 3/8 N1/4 W	\$13.19	MES 3/8 N1/4 W	\$26.27	RTS 3/8 N1/4 W	\$40.26
3/8"	NPT3/8	BCS 3/8 N3/8 W	\$35.56	BTS 3/8 N3/8 W	\$40.26	FCS 3/8 N3/8 W	\$21.49	MCS 3/8 N3/8 W	\$13.39	MES 3/8 N3/8 W	\$27.26	RTS 3/8 N3/8 W	\$40.26
3/8"	NPT1/2	BCS 3/8 N1/2 W	\$35.56	BTS 3/8 N1/2 W	\$44.75	FCS 3/8 N1/2 W	\$22.24	MCS 3/8 N1/2 W	\$15.08	MES 3/8 N1/2 W	\$31.23	RTS 3/8 N1/2 W	\$44.75
1/2"	NPT1/4	BCS 1/2 N1/4 W	\$38.35	BTS 1/2 N1/4 W	\$44.09	FCS 1/2 N1/4 W	\$19.95	MCS 1/2 N1/4 W	\$16.17	MES 1/2 N1/4 W	\$33.51	RTS 1/2 N1/4 W	\$44.09
1/2"	NPT3/8	BCS 1/2 N3/8 W	\$39.76	BTS 1/2 N3/8 W	\$44.09	FCS 1/2 N3/8 W	\$22.24	MCS 1/2 N3/8 W	\$16.17	MES 1/2 N3/8 W	\$33.51	RTS 1/2 N3/8 W	\$44.09
1/2"	NPT1/2	BCS 1/2 N1/2 W	\$42.63	BTS 1/2 N1/2 W	\$47.11	FCS 1/2 N1/2 W	\$22.96	MCS 1/2 N1/2 W	\$21.32	MES 1/2 N1/2 W	\$38.16	RTS 1/2 N1/2 W	\$47.11

4 mm	M5	BCS 4 M5 W	\$26.89	BTS 4 M5 W	\$27.86	FCS 4 M5 W	\$11.57	MCS 4 M5 W	\$9.92	MES 4 M5 W	\$19.72	RTS 4 M5 W	\$27.86
4 mm	R1/8	BCS 4 R1/8 W	\$26.89	BTS 4 R1/8 W	\$27.86	FCS 4 R1/8 W	\$11.57	MCS 4 R1/8 W	\$9.92	MES 4 R1/8 W	\$19.72	RTS 4 R1/8 W	\$27.86
4 mm	R1/4	BCS 4 R1/4 W	\$26.89	BTS 4 R1/4 W	\$27.86	FCS 4 R1/4 W	\$11.57	MCS 4 R1/4 W	\$11.43	MES 4 R1/4 W	\$19.72	RTS 4 R1/4 W	\$27.86
6mm	M5	BCS 6 M5 W	\$30.51	BTS 6 M5 W	\$27.86	FCS 6 M5 W	\$11.57	MCS 6 M5 W	\$11.43	MES 6 M5 W	\$22.70	RTS 6 M5 W	\$27.86
6mm	R1/8	BCS 6 R1/8 W	\$30.51	BTS 6 R1/8 W	\$27.86	FCS 6 R1/8 W	\$11.57	MCS 6 R1/8 W	\$11.43	MES 6 R1/8 W	\$21.01	RTS 6 R1/8 W	\$27.86
6mm	R1/4	BCS 6 R1/4 W	\$30.51	BTS 6 R1/4 W	\$32.04	FCS 6 R1/4 W	\$11.57	MCS 6 R1/4 W	\$11.43	MES 6 R1/4 W	\$22.70	RTS 6 R1/4 W	\$32.04
6mm	R3/8	BCS 6 R3/8 W	\$31.93			FCS 6 R3/8 W	\$14.85	MCS 6 R 3/8 W	\$13.94	MES 6 R3/8 W	\$28.24		
8mm	R1/8	BCS 8 R1/8 W	\$31.93			FCS 8 R1/8 W	\$14.85	MCS 8 R1/8 W	\$13.19	MES 8 R1/8 W	\$25.20	RTS 8 R1/8 W	\$35.03
8 mm	R1/4	BCS 8 R1/4 W	\$31.93	BTS 8 R1/4 W	\$35.03	FCS 8 R1/4 W	\$14.85	MCS 8 R1/4 W	\$13.19	MES 8 R1/4 W	\$25.20	RTS 8 R1/4 W	\$35.03
8 mm	R3/8	BCS 8 R3/8 W	\$31.93	BTS 8 R3/8 W	\$38.06	FCS 8 R3/8 W	\$16.33	MCS 8 R3/8 W	\$13.94	MES 8 R3/8 W	\$25.36	RTS 8 R3/8 W	\$38.06
10mm	R1/4	BCS 10 R1/4 W	\$35.56	BTS 10 R1/4 W	\$40.26	FCS 10 R1/4 W	\$17.83	MCS 10 R1/4 W	\$13.19	MES 10 R1/4 W	\$26.27	RTS 10 R1/4 W	\$40.26
10mm	R3/8	BCS 10 R3/8 W	\$35.56	BTS 10 R3/8 W	\$40.26	FCS 10 R3/8 W	\$19.04	MCS 10 R3/8 W	\$13.39	MES 10 R3/8 W	\$27.26	RTS 10 R3/8 W	\$40.26
12mm	R1/4	BCS 12 R1/4 W	\$39.76			FCS 12 R1/4 W	\$19.95	MCS 12 R1/4 W	\$16.17	MES 12 R1/4 W	\$38.16		
12mm	R3/8	BCS 12 R3/8 W	\$39.76	BTS 12 R3/8 W	\$44.09	FCS 12 R3/8 W	\$19.95	MCS 12 R3/8 W	\$16.17	MES 12 R3/8 W	\$33.51	RTS 12 R3/8 W	\$44.09
12mm	R1/2	BCS 12 R1/2 W	\$39.76	BTS 12 R1/2 W	\$47.11	FCS 12 R1/2 W	\$22.96	MCS 12 R1/2 W	\$21.32	MES 12 R1/2 W	\$38.16	RTS 12 R1/2 W	\$47.11

# Stainless Steel Push-In Fittings List Price

Stainless Steel Fittings								
	Bulkhead Union		Elbow Union		Hex Plug		Plug	
	BUS		EUS		PGS		PGS	
Model	Part No.	Unit Price	Part No.	Unit Price	Part No.	Price	Part No.	Price
Tube OD								
1/8"	BUS 1/8 W	\$18.94	EUS 1/8 W	\$22.71	PGS N1/8	\$6.57	PGS 1/8	\$3.26
5/32"	BUS 5/32 W	\$18.94	EUS 5/32 W	\$22.70			PGS 5/32	\$2.60
1/4"	BUS 1/4 W	\$22.31	EUS 1/4 W	\$26.08	PGS N1/4	\$6.34	PGS 1/4	\$3.26
5/16"	BUS 5/16 W	\$28.54	EUS 5/16 W	\$27.26			PGS 5/16	\$1.83
3/8"	BUS 3/8 W	\$30.34	EUS 3/8 W	\$29.73	PGS N3/8	\$8.35	PGS 3/8	\$1.88
1/2"	BUS 1/2 W	\$39.14	EUS 1/2 W	\$34.21	PGS N1/2	\$20.05	PGS 1/2	\$2.29

4 mm	BUS 4 W	\$18.94	EUS 4 W	\$22.70				
6 mm	BUS 6 W	\$26.77	EUS 6 W	\$26.08			PGS 6	\$2.29
8 mm	BUS 8 W	\$28.54	EUS 8 W	\$27.26				
10 mm	BUS 10 W	\$30.34	EUS 10 W	\$29.73			PGS 10	\$2.29
12 mm	BUS 12 W	\$39.14	EUS 12 W	\$34.21			PGS 12	\$2.29

Stainless Steel Fittings								
	Straight Union		Tube Connector		Tee Union		Cartridge Fitting	
	SUS		TCS		TUS		CFS	
Model	Part No.	Unit Price	Part No.	Unit Price	Part No.	Unit Price	Part No.	Unit Price
Tube OD								
1/8"	SUS 1/8 W	\$14.28	TCS 1/8	\$3.41	TUS 1/8 W	\$27.86	CFS 1/8 W	\$12.60
5/32"	SUS 5/32 W	\$14.28	TCS 5/32	\$3.41	TUS 5/32 W	\$27.86	CFS 5/32 W	\$11.31
1/4"	SUS 1/4 W	\$14.28	TCS 1/4	\$3.41	TUS 1/4 W	\$32.04	CFS 1/4 W	\$9.73
5/16"	SUS 5/16 W	\$15.56	TCS 5/16	\$3.41	TUS 5/16 W	\$36.16	CFS 5/16 W	\$10.59
3/8"	SUS 3/8 W	\$16.86	TCS 3/8	\$4.10	TUS 3/8 W	\$40.26	CFS 3/8 W	\$11.16
1/2"	SUS 1/2 W	\$20.41	TCS 1/2	\$4.77	TUS 1/2 W	\$47.11	CFS 1/2 W	\$11.88

4 mm	SUS 4 W	\$14.28			TUS 4 W	\$27.86	CFS 4 W	\$11.31
6 mm	SUS 6 W	\$14.28			TUS 6 W	\$32.04	CFS 6 W	\$9.73
8 mm	SUS 8 W	\$15.56			TUS 8 W	\$36.16	CFS 8 W	\$10.59
10 mm	SUS 10 W	\$16.86	TCS 10	\$4.10	TUS 10 W	\$40.26	CFS 10 W	\$11.16
12 mm	SUS 12 W	\$20.41			TUS 12 W	\$47.11	CFS 12 W	\$11.88

Stainless Steel Fittings											
	Reduced Union		Tube Reducer		Tube Adaptor		Hex Bushing				
	RUS		TRS		TAS		HBS				
Model	Part No.	Unit Price	Part No.	Unit Price	Model	Part No.	Unit Price	Part No.	Unit Price		
ØD1	ØD2				Tube OD	Thread					
1/8"	5/32"	RUS 5/32-1/8 W	\$18.94		1/8"	10-32	TAS 1/8 10-32	\$6.29			
5/32"	1/8"			TRS 1/8-5/32 W	\$14.28	1/8"	NPT1/8	TAS 1/8 N1/8	\$6.29	HBS MN1/4-FN1/8	\$3.46
5/32"	1/4"	RUS 1/4-5/32 W	\$22.31			1/4"	NPT1/8	TAS 1/4 N1/8	\$6.29		
1/4"	5/32"			TRS 5/32-1/4 W	\$14.28	1/4"	NPT1/4	TAS 1/4 N1/4	\$6.29		
3/8"	1/4"	RUS 3/8-1/4 W	\$30.34			1/4"	NPT3/8	TAS 1/4 N3/8	\$6.29		
3/8"	5/16"	RUS 3/8-5/16 W	\$30.34	TRS 1/4-3/8 W	\$14.28	5/16"	NPT1/4	TAS 5/16 N1/4	\$9.27		
3/8"	1/2"	RUS 1/2-3/8 W	\$39.14	TRS 5/16-3/8 W	\$15.56	5/16"	NPT3/8	TAS 5/16 N3/8	\$9.27		
1/2"	3/8"			TRS 3/8-1/2 W	\$16.86	3/8"	NPT1/8	TAS 3/8 N1/8	\$8.82	HBS MN3/8-FN1/8	\$4.33
						3/8"	NPT1/4	TAS 3/8 N1/4	\$9.27	HBS MN3/8-FFN1/4	\$5.19
6mm	4mm	RUS 6-4 W	\$26.77	TRS 4-6 W	\$12.79	3/8"	NPT3/8	TAS 3/8 N3/8	\$13.10		
8mm	6mm	RUS 8-6 W	\$28.51	TRS 6-8 W	\$14.28	3/8"	NPT1/2	TAS 3/8 N1/2	\$13.10		
10mm	6mm	RUS 10-6 W	\$27.57			1/2"	NPT1/4	TAS 1/2 N1/4	\$15.71	HBS MN1/2-FN1/4	\$5.19
10mm	8mm	RUS 10-8 W	\$30.34	TRS 8-10 W	\$15.56	1/2"	NPT3/8	TAS 1/2 N3/8	\$15.71	HBS MN1/2-FN3/8	\$5.19
12mm	10mm	RUS 12-10 W	\$39.14	TRS 10-12 W	\$16.86	1/2"	NPT1/2	TAS 1/2 N1/2	\$15.71		

6mm	N1/4	TAS 6 N1/4	\$6.29		
-----	------	------------	--------	--	--

**A. Installation of Pipe Fittings:**

Tighten fitting by hand, then turn it 2-3 turns with a wrench until it reaches the desired torque listed. If the fittings are not pre-coated with sealant, or is used and the sealant is not in good condition, apply Teflon sealant tape to the threads.

Recommendation of Torque for Tightening Fittings		
Fitting Thread Size	Torque, lb-ft	Torque, kgf/cm
10-32, M5 – M6	1.0 – 1.5	14 – 21
NPT1/8, R1/8	5 – 6.5	70 – 90
NPT1/4, R1/4	8.5 – 10	120 – 140
NPT3/8, R3/8	16 – 17.5	220 – 240
NPT1/2, R1/2	20 – 21.5	280 – 300

**B. Installation of Tubing into Fitting:**

1. Slowly push a clean and perpendicularly cut tube into the fitting until it comes to a dead stop.
2. Gently pull the tubing back until the Grip Ring or Collet of the fitting grips onto the tubing and has a good seal.
3. Use Polyethylene, Polypropylene, Polyurethane, or Nylon tubing designed for instant fittings.
4. Hard metal tubing can be used for all metal Stainless Steel if the tubing is pre-grooved.

**C. Removal of Tubing from Fitting:**

1. Push in evenly on the Release Button.
2. Pull out the tube while depressing the Release Button.
3. To reuse the tubing, cut off the lodged portion of the previously used tubing in an even and perpendicular fashion.

**D. Recommended Tubing Material, Size, and Hardness Requirements:**

Tubing Material	Specified Size	Hardness (Durometer)
Polyurethane	+/- 0.006" (+/-0.15 mm)	Shore A 85 or higher
Polyethylene	+/- 0.004" (+/-0.1 mm)	Shore D 44—D75
Polypropylene	+/- 0.004" (+/-0.1 mm)	Shore D 44—D75
Nylon	+/- 0.004" (+/-0.1 mm)	Shore D 44—D75
Pre-grooved Metal Tubing	+/- 0.004" (+/-0.1 mm)	

**E. Specifications, Materials of Construction, and Schematics of Typical Construction:**

Stainless Steel Fittings	
Operating Pressure Range	0 - 250 PSI (0 - 1650 kpa)
Vacuum	0 - 30" Hg (0 - 760 mm Hg)
Operating Temperature	5 - 230°F (-15 to 110°C)
Recommended Tubing Material	Polyurethane, Nylon, Polyethylene, Polypropylene, and Hard metal tubing (tubing must be pre-grooved)
Metal Body	T316 Stainless Steel
Plastic Body	None
Release Button	300 series Stainless Steel
Grip Ring or Collet	300 series Stainless Steel
O-ring	VITON
Thread Sealant	None
Service	Air, Liquid
Sterilization Temperature	Up to 280°F (138°C)

Stainless Steel (SS) Gripper-Style (W) Fitting  
Materials of Construction

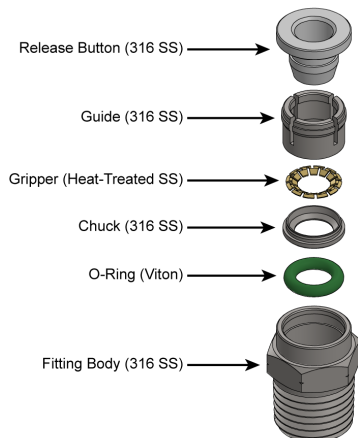

Stainless Steel (SS) Collet-Style Fitting  
Materials of Construction

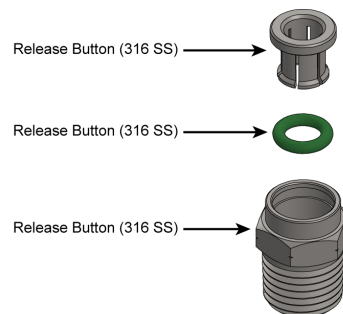

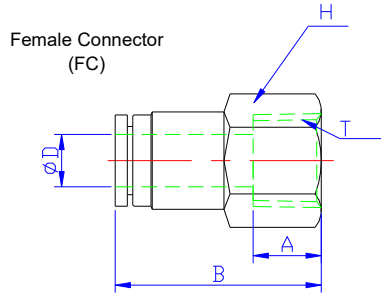

Model		Bulkhead Connector					Female Connector	
ΦD	T, Thread	B	BCS			FCS		
			Part No.	H1	H2	M	Part No.	H
1/8	10-32	24.2	BCS 1/8 10-32 W	S14	S14	M12X1	FCS 1/8 10-32 W	S11
1/8	1/8 NPT	27.2	BCS 1/8 N1/8 W	S14	S14	M12X1	FCS 1/8 N1/8 W	S14
1/8	1/4 NPT	30.2	BCS 1/8 N1/4 W	S17	S17	M14X1	FCS 1/8 N1/4 W	S17
5/32	10-32	24.2	BCS 5/32 10-32 W	S14	S14	M12X1	FCS 5/32 10-32 W	S11
5/32	1/8 NPT	27.2	BCS 5/32 N1/8 W	S14	S14	M12X1	FCS 5/32 N1/8 W	S14
5/32	1/4 NPT	30.2	BCS 5/32 N1/4 W	S17	S17	M12X1	FCS 5/32 N1/4 W	S17
3/16	1/8 NPT	29.2	BCS 3/16 N1/8 W	S17	S17	M14X1	FCS 3/16 N1/8 W	S14
3/16	1/4 NPT	32.2	BCS 3/16 N1/4 W	S17	S17	M14X1	FCS 3/16 N1/4 W	S17
1/4	10-32	26.2	BCS 1/4 10-32 W	S17	S17	M14X1	FCS 1/4 10-32 W	S14
1/4	1/8 NPT	29.2	BCS 1/4 N1/8 W	S17	S17	M14X1	FCS 1/4 N1/8 W	S14
1/4	1/4 NPT	32.2	BCS 1/4 N1/4 W	S17	S17	M14X1	FCS 1/4 N1/4 W	S17
1/4	3/8 NPT	33.2	BCS 1/4 N3/8 W	S19	S19	M14X1	FCS 1/4 N3/8 W	S19
5/16	1/8 NPT	31.1	BCS 5/16 N1/8 W	S19	S19	M17X1	FCS 5/16 N1/8 W	S17
5/16	1/4 NPT	34.1	BCS 5/16 N1/4 W	S19	S19	M17X1	FCS 5/16 N1/4 W	S17
5/16	3/8 NPT	37.1	BCS 5/16 N3/8 W	S19	S19	M17X1	FCS 5/16 N3/8 W	S19
3/8	1/8 NPT	34	BCS 3/8 N1/8 W	S21	S21	M19X1	FCS 3/8 N1/8 W	S19
3/8	1/4 NPT	37	BCS 3/8 N1/4 W	S21	S21	M19X1	FCS 3/8 N1/4 W	S19
3/8	3/8 NPT	38	BCS 3/8 N3/8 W	S21	S21	M19X1	FCS 3/8 N3/8 W	S19
3/8	1/2 NPT	40	BCS 3/8 N1/2 W	S24	S24	M22X1	FCS 3/8 N1/2 W	S24
1/2	1/4 NPT	39.5	BCS 1/2 N1/4 W	S24	S24	M22X1	FCS 1/2 N1/4 W	S22
1/2	3/8 NPT	40.5	BCS 1/2 N3/8 W	S24	S24	M22X1	FCS 1/2 N3/8 W	S22
1/2	1/2 NPT	42.5	BCS 1/2 N1/2 W	S24	S24	M22X1	FCS 1/2 N1/2 W	S24

4	M5	24.2	BCS 4 M5 W	S14	S14	M12X1	FCS 4 M5 W	S11
4	1/8 BSPT	27.2	BCS 4 R1/8 W	S14	S14	M12X1	FCS 4 R1/8 W	S14
4	1/4 BSPT	30.2	BCS 4 R1/4 W	S17	S17	M14X1	FCS 4 R1/4 W	S17
6	M5	26.2	BCS 6 M5 W	S17	S17	M14X1	FCS 6 M5 W	S14
6	1/8 BSPT	29.2	BCS 6 R1/8 W	S17	S17	M14X1	FCS 6 R1/8 W	S14
6	1/4 BSPT	32.2	BCS 6 R1/4 W	S17	S17	M14X1	FCS 6 R1/4 W	S17
6	3/8 BSPT	33.2	BCS 6 R3/8 W	S19	S19	M17X1	FCS 6 R3/8 W	S19
8	1/8 BSPT	31.1	BCS 8 R1/8 W	S19	S19	M17X1	FCS 8 R1/8 W	S17
8	1/4 BSPT	34.1	BCS 8 R1/4 W	S19	S19	M17X1	FCS 8 R1/4 W	S17
8	3/8 BSPT	37.1	BCS 8 R3/8 W	S19	S19	M17X1	FCS 8 R3/8 W	S19
8	1/2 BSPT	39.1	BCS 8 R1/2 W	S24	S24	M22X1	FCS 8 R1/2 W	S24
10	1/8 BSPT	34	BCS 10 R1/8 W	S21	S21	M19X1	FCS 10 R1/8 W	S19
10	1/4 BSPT	37	BCS 10 R1/4 W	S21	S21	M19X1	FCS 10 R1/4 W	S19
10	3/8 BSPT	38	BCS 10 R3/8 W	S21	S21	M19X1	FCS 10 R3/8 W	S21
10	1/2 BSPT	40	BCS 10 R1/2 W	S24	S24	M22X1	FCS 10 R1/2 W	S24
12	1/4 BSPST	39.5	BCS 12 R1/4 W	S24	S24	M22X1	FCS 12 R1/4 W	S22
12	3/8 BSPT	40.5	BCS 12 R3/8 W	S24	S24	M22X1	FCS 12 R3/8 W	S22
12	1/2 BSPT	42.5	BCS 12 R1/2 W	S24	S24	M22X1	FCS 12 R1/2 W	S24

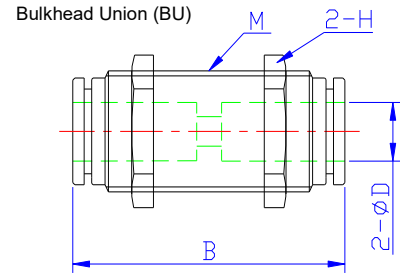

Bulkhead Union				
BUS				
ΦD	Part No.	B	H	M
1/8"	BUS 1/8 W	34.5	S14	M12X1
5/32"	BUS 5/32 W	35.1	S14	M12X1
3/16"	BUS 3/16 W	38.05	S17	M14X1
1/4"	BUS 1/4 W	38.05	S17	M14X1
5/16"	BUS 5/16 W	42.7	S19	M17X1
3/8"	BUS 3/8 W	48.4	S21	M19X1
1/2"	BUS 1/2 W	52.5	S24	M22X1

4	BUS 4 W	35.1	S14	M12X1
6	BUS 6 W	38.05	S17	M14X1
8	BUS 8 W	42.7	S19	M17X1
10	BUS 10 W	48.4	S21	M19X1
12	BUS 12 W	52.5	S24	M22X1

Model		Tube Reducer		
ΦD1	ΦD2	TR		
		Part No.	B	C
1/4	5/32	TRS 5/32-1/4W	33.4	9
5/16	5/32	TRS 5/32-5/16W	36.4	10.5
5/16	1/4	TRS 1/4-5/16W	40.3	10.5
3/8	1/4	TRS 1/4-3/8W	36.9	10.5
3/8	5/16	TRS 5/16-3/8W	43.1	10.5
1/2	1/4	TRS 1/4-1/2W	36.9	10.5
1/2	5/16	TRS 5/16-1/2W	39.1	10.5
1/2	3/8	TRS 3/8-1/2W	41.5	10.5



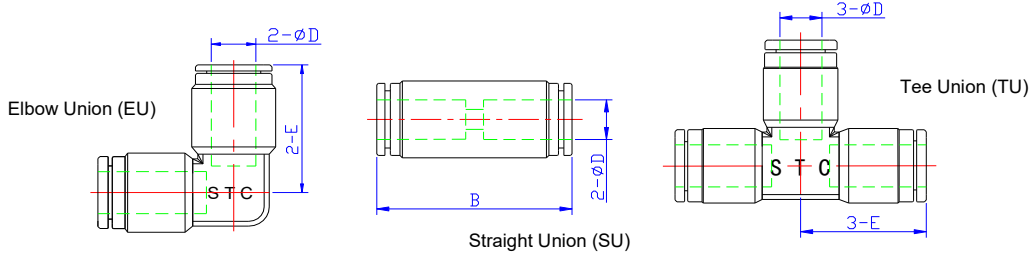

Model	Elbow Union		Reducing Union		Straight Union		Tee Union		Plug				
	EUS		RUS		SUS		TUS		PG S				
ΦD	Part No.	E	Part No.	B	Part No.	B	Part No.	E	Part No.	B	P1	P2	C
1/8"	EUS 1/8 W	20.2	RUS 1/8-5/32 W	35.2	SUS 1/8 W	34.5	TUS 1/8 W	20.2	PGS 5/32	25	5	2.5	13
5/32"	EUS 5/32 W	20.2	RUS 5/32-1/4 W	37	SUS 5/32 W	35.1	TUS 5/32 W	20.2	PGS 3/16	31	6	2.5	15
3/16"	EUS 3/16 W	22.6	RUS 1/4-5/16 W	40.9	SUS 1/4 W	38.05	TUS 1/4 W	22.3	PGS 1/4	33	7	3	17
1/4"	EUS 1/4 W	22.3	RUS 5/16-3/8 W	47.05	SUS 5/16 W	42.7	TUS 5/16 W	24.1	PGS 5/16	37	9	4	18
5/16"	EUS 5/16 W	23.9	RUS 3/8-1/2 W	52	SUS 3/8 W	48.4	TUS 3/8 W	27.2	PGS 3/8	42	11	5	23
3/8"	EUS 3/8 W	30.5	RUS 1/2 W		SUS 1/2 W	52.5	TUS 1/2 W	31.9	PGS 1/2	44	13	6	23

4mm	EUS 4 W	20.2	RUS 4-6 W	37	SUS 4 W	35.1	TUS 4 W	20.2	PGS 4	25	5	2.5	13
6mm	EUS 6 W	22.3	RUS 6-8 W	40.9	SUS 6 W	38.05	TUS 6 W	22.3	PGS 6	33	7	3	17
8mm	EUS 8 W	23.9	RUS 8-10 W	47.05	SUS 8 W	42.7	TUS 8 W	24.1	PGS 8	37	9	4	18
10mm	EUS 10 W	30.5	RUS 10-12 W	52	SUS 10 W	48.4	TUS 10 W	27.2	PGS 10	42	11	5	23
12mm	EUS 12 W	32.2			SUS 12 W	52.5	TUS 12 W	31.9	PGS 12	44	13	6	23

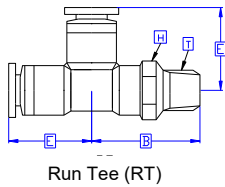

Model	Run Tee					Tube Adaptor			
	Tube OD	T, Thread	Part No.	A	B	E	Part No.	A	B
1/8"	10-32	RTS 1/8 10-32W	5.4	21.85	20.2	TAS 1/8 10-32	23.4	13	S11
1/8"	1/8 NPT	RTS 1/8 N1/8W	8.2	19.5	20.2	TAS 1/8 N1/8	26.2	13	S11
1/8"	1/4 NPT	RTS 1/8 N1/4W	11.5	22.8	20.2	TAS 1/8 N1/4	29.5	13	S14
5/32"	10-32	RTS 5/32 10-32W	5.4	21.85	20.2	TAS 5/32 10-32	25.4	15	S11
5/32"	1/8 NPT	RTS 5/32 N1/8W	8.2	19.5	20.2	TAS 5/32 N1/8	28.2	15	S11
5/32"	1/4 NPT	RTS 5/32 N1/4W	11.5	22.8	20.2				
3/16"	1/8 NPT	RTS 3/16 N1/8W	8.2	21.3	22.6	TAS 3/16 N1/8	28.2	15	S11
3/16"	1/4 NPT	RTS 3/16 N1/4W	11.5	23.9	22.6	TAS 3/16 N1/4	31.5	15	S14
1/4"	10-32	RTS 1/4 10-32W	5.4	20.9	22.3	TAS 1/4 10-32	28.4	18	S11
1/4"	1/8 NPT	RTS 1/4 N1/8W	8.2	21.3	22.3	TAS 1/4 N1/8	31.2	18	S11
1/4"	1/4 NPT	RTS 1/4 N1/4W	11.5	23.9	22.3	TAS 1/4 N1/4	34.5	18	S14
1/4"	3/8 NPT	RTS 1/4 N3/8W	12.5	24.9	22.3	TAS 1/4 N3/8	35.5	18	S18
5/16"	1/8 NPT	RTS 5/16 N1/8W	8.2	22.3	24.1	TAS 5/16 N1/8	34.2	21	S11
5/16"	1/4 NPT	RTS 5/16 N1/4W	11.5	24.4	24.1	TAS 5/16 N1/4	37.5	21	S14
5/16"	3/8 NPT	RTS 5/16 N3/8W	12.5	25.9	24.1	TAS 5/16 N3/8	38.5	21	S18
3/8"	1/8 NPT	RTS 3/8 N1/8W	8.2	24.15	27.2	TAS 3/8 N1/8	34.2	21	S11
3/8"	1/4 NPT	RTS 3/8 N1/4W	11.5	27.5	27.2	TAS 3/8 N1/4	37.5	21	S14
3/8"	3/8 NPT	RTS 3/8 N3/8W	12.5	27.2	27.2	TAS 3/8 N3/8	38.5	21	S18
3/8"	1/2 NPT	RTS 3/8 N1/2W	15	30.1	27.2	TAS 3/8 N1/2	41	21	S22
1/2"	1/4 NPT	RTS 1/2 N1/4W	11.5	32.2	31.9	TAS 1/2 N1/4	37.5	21	S14
1/2"	3/8 NPT	RTS 1/2 N3/8W	12.5	29.8	31.9	TAS 1/2 N3/8	38.5	21	S18
1/2"	1/2 NPT	RTS 1/2 N1/2W	15	32.3	31.9	TAS 1/2 N1/2	41	21	S22

4mm	M5	RTS 4 M5W	5.4	21.85	20.2	TAS 4 M5	25.4	15	S11
4mm	1/8 BSPT	RTS 4 R1/8W	8.2	19.5	20.2	TAS 4 R1/8	28.2	15	S11
4mm	1/4 BSPT	RTS 4 R1/4W	11.5	22.8	20.2	TAS 4 1/4	31.5	15	S14
6mm	M5	RTS 6 M5W	5.4	20.9	22.3	TAS 6 M5	28.4	18	S11
6mm	1/8 BSPT	RTS 6 R1/8W	8.2	21.3	22.3	TAS 6 R1/8	31.2	18	S11
6mm	1/4 BSPT	RTS 6 R1/4W	11.5	23.9	22.3	TAS 6 R1/4	34.5	18	S14
6mm	3/8 BSPT	RTS 6 R3/8W	12.5	24.9	22.3	TAS 6 R3/8	35.5	18	S18
8mm	1/8 BSPT	RTS 8 R1/8W	8.2	22.3	24.1	TAS 8 R1/8	34.2	21	S11
8mm	1/4 BSPT	RTS 8 R1/4W	11.5	24.4	24.1	TAS 8 R1/4	37.5	21	S14
8mm	3/8 BSPT	RTS 8 R3/8W	12.5	25.9	24.1	TAS 8 R3/8	38.5	21	S18
8mm	1/2 BSPT	RTS 8 R1/2W	15	28.4	24.1	TAS 8 R1/2	41	21	S22
10mm	1/8 BSPT	RTS 10 R1/8W	8.2	24.15	27.2	TAS 10 R1/8	34.2	21	S11
10mm	1/4 BSPT	RTS 10 R1/4W	11.5	27.5	27.2	TAS 10 R1/4	37.5	21	S14
10mm	3/8 BSPT	RTS 10 R3/8W	12.5	27.2	27.2	TAS 10 R3/8	38.5	21	S18
10mm	1/2 BSPT	RTS 10 R1/2W	15	30.1	27.2	TAS 10 R1/2	41	21	S22
12mm	1/4 BSPT	RTS 12 R1/4W	11.5	32.2	31.9	TAS 12 R1/4	37.5	21	S14
12mm	3/8 BSPT	RTS 12 R3/8W	12.5	29.8	31.9	TAS 12 R3/8	38.5	21	S18
12mm	1/2 BSPT	RTS 12 R1/2W	15	32.3	31.9	TAS 12 R1/2	41	21	S22

Units in mm

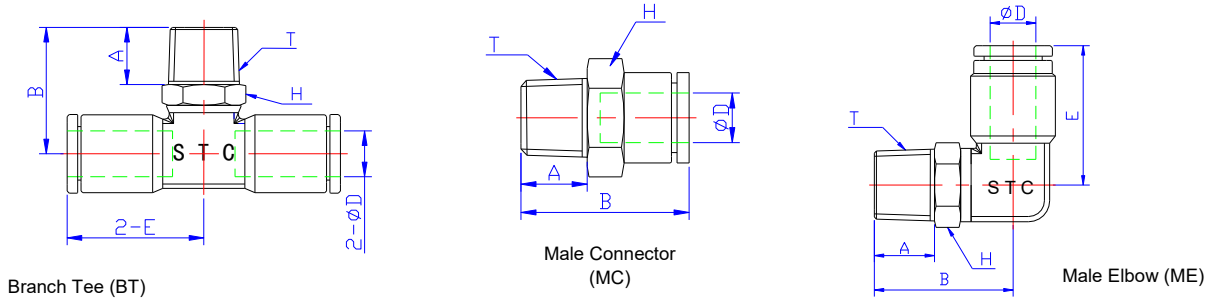

Model			Branch Tee				Male Connector				Male Elbow			
ΦD	T, Thread	H	BTS			MCS			MES					
			Part No.	A	B	E	Part No.	A	B	H	Part No.	A	B	E
1/8"	10-32	S11	BTS 1/8 10-32W	5.4	21.85	20.2	MCS 1/8 10-32W	4.8	23.2	S11	MES 1/8 10-32W	5.4	21.85	20.2
1/8"	1/8 NPT	S11	BTS 1/8 N1/8W	8.2	19.5	20.2	MCS 1/8 N1/8W	8	20.4	S11	MES 1/8 N1/8W	8.2	19.5	20.2
1/8"	1/4 NPT	S14	BTS 1/8 N1/4W	11.5	22.8	20.2	MCS 1/8 N1/4W	11.5	23.4	S14	MES 1/8 N1/4W	11.5	22.8	20.2
5/32"	10-32	S11	BTS 5/32 10-32W	5.4	21.85	20.2	MCS 5/32 10-32W	4.8	23.2	S11	MES 5/32 10-32W	5.4	21.85	20.2
5/32"	1/8 NPT	S11	BTS 5/32 N1/8W	8.2	19.5	20.2	MCS 5/32 N1/8W	8	20.4	S11	MES 5/32 N1/8W	8.2	19.5	20.2
5/32"	1/4 NPT	S14	BTS 5/32 N1/4W	11.5	22.8	20.2	MCS 5/32 N1/4W	11	21.5	S14	MES 5/32 N1/4W	11.5	22.8	20.2
3/16"	1/8 NPT	S11	BTS 3/16 N1/8W	8.2	21.3	22.6	MCS 3/16 N1/8W	8.2	23.6	S14	MES 3/16 N1/8W	8.2	21.3	22.6
3/16"	1/4 NPT	S14	BTS 3/16 N1/4W	11.5	23.9	22.6	MCS 3/16 N1/4W	11.5	23.6	S14	MES 3/16 N1/4W	11.5	23.9	22.6
1/4"	10-32	S12	BTS 1/4 10-32W	5.4	20.9	22.3	MCS 1/4 10-32W	4.8	25.4	S14	MES 1/4 10-32W	5.4	20.9	22.3
1/4"	1/8 NPT	S11	BTS 1/4 N1/8W	8.2	21.3	22.3	MCS 1/4 N1/8W	8.2	23.6	S14	MES 1/4 N1/8W	8.2	21.3	22.3
1/4"	1/4 NPT	S14	BTS 1/4 N1/4W	11.5	23.9	22.3	MCS 1/4 N1/4W	11.5	23.6	S14	MES 1/4 N1/4W	11.5	23.9	22.3
1/4"	3/8 NPT	S18	BTS 1/4 N3/8W	12.5	24.9	22.3	MCS 1/4 N3/8W	12	24.6	S18	MES 1/4 N3/8W	12.5	24.9	22.3
5/16"	1/8 NPT	S11	BTS 5/16 N1/8W	8.2	22.3	24.1	MCS 5/16 N1/8W	8.2	30.3	S17	MES 5/16 N1/8W	8.2	22.3	23.9
5/16"	1/4 NPT	S14	BTS 5/16 N1/4W	11.5	24.4	24.1	MCS 5/16 N1/4W	11.5	29.1	S17	MES 5/16 N1/4W	11.5	24.4	23.9
5/16"	3/8 NPT	S18	BTS 5/16 N3/8W	12.5	25.9	24.1	MCS 5/16 N3/8W	12.5	25.6	S18	MES 5/16 N3/8W	12.5	25.9	23.9
5/16"	1/2 NPT	S22					MCS 5/16 N1/2W	15	31.2	S22	MES 5/16 N1/2W	15	28.5	23.9
3/8"	1/8 NPT	S11	BTS 3/8 N1/8W	8.2	24.15	27.2	MCS 3/8 N1/8W	8.2	34.7	S18	MES 3/8 N1/8W	8.2	24.65	30.5
3/8"	1/4 NPT	S14	BTS 3/8 N1/4W	11.5	27.5	27.2	MCS 3/8 N1/4W	11.5	36.4	S18	MES 3/8 N1/4W	11.5	28	30.5
3/8"	3/8 NPT	S18	BTS 3/8 N3/8W	12.5	27.2	27.2	MCS 3/8 N3/8W	12.5	32.5	S18	MES 3/8 N3/8W	12.5	27.7	30.5
3/8"	1/2 NPT	S22	BTS 3/8 N1/2W	15	30.1	27.2	MCS 3/8 N1/2W	15	31.5	S22	MES 3/8 N1/2W	15	30	30.5
1/2"	1/4 NPT	S14	BTS 1/2 N1/4W	11.5	32.2	31.9	MCS 1/2 N1/4W	11.5	40.2	S22	MES 1/2 N1/4W	11.5	32.5	32.2
1/2"	3/8 NPT	S18	BTS 1/2 N3/8W	12.5	29.8	31.9	MCS 1/2 N3/8W	12.5	36.7	S22	MES 1/2 N3/8W	12.5	29.6	32.2
1/2"	1/2 NPT	S22	BTS 1/2 N1/2W	15	32.3	31.9	MCS 1/2 N1/2W	15	33.7	S22	MES 1/2 N1/2W	15	32.6	32.2

4	M5	S11	BTS 4 M5W	5.4	21.85	20.2	MCS 4 M5W	4.8	23.2	S11	MES 4 M5W	5.4	21.85	20.2
4	1/8 BSPT	S11	BTS 4 R1/8W	8.2	19.5	20.2	MCS 4 R1/8W	8	20.4	S11	MES 4 R1/8W	8.2	19.5	20.2
4	1/4 BSPT	S14	BTS 4 R1/4W	11.5	22.8	20.2	MCS 4 R1/4W	11.5	23.4	S14	MES 4 R1/4W	11.5	22.8	20.2
6	M5	S11	BTS 6 M5W	5.4	20.9	22.3	MCS 6 M5W	4.8	25.4	S14	MES 6 M5W	5.4	20.9	22.3
6	1/8 BSPT	S11	BTS 6 R1/8W	8.2	21.3	22.3	MCS 6 R1/8W	8.2	23.6	S14	MES 6 R1/8W	8.2	21.3	22.3
6	1/4 BSPT	S14	BTS 6 R1/4W	11.5	23.9	22.3	MCS 6 R1/4W	11.5	23.6	S14	MES 6 R1/4W	11.5	23.9	22.3
6	3/8 BSPT	S18	BTS 6 R3/8W	12.5	24.9	22.3	MCS 6 R3/8W	12	24.6	S18	MES 6 R3/8W	12.5	24.9	22.3
8	1/8 BSPT	S11	BTS 8 R1/8W	8.2	22.3	24.1	MCS 8 R1/8W	8.2	30.3	S17	MES 8 R1/8W	8.2	22.3	23.9
8	1/4 BSPT	S14	BTS 8 R1/4W	11.5	24.4	24.1	MCS 8 R1/4W	11.5	29.1	S17	MES 8 R1/4W	11.5	24.4	23.9
8	3/8 BSPT	S18	BTS 8 R3/8W	12.5	25.9	24.1	MCS 8 R3/8W	12.5	25.6	S18	MES 8 R3/8W	12.5	25.9	23.9
8	1/2 BSPT	S22	BTS 8 R1/2W	15	28.4	24.1	MCS 8 R1/2W	15	30.1	S22	MES 8 R1/2W	15	28.4	23.9
10	1/8 BSPT	S11	BTS 10 R1/8W	8.2	24.15	27.2	MCS 10 R1/8W	8.2	34.7	S18	MES 10 R1/8W	8.2	24.65	30.5
10	1/4 BSPT	S14	BTS 10 R1/4W	11.5	27.5	27.2	MCS 10 R1/4W	11.5	36.5	S18	MES 10 R1/4W	11.5	28	30.5
10	3/8 BSPT	S18	BTS 10 R3/8W	12.5	27.2	27.2	MCS 10 R3/8W	12.5	32.5	S18	MES 10 R3/8W	12.5	27.7	30.5
10	1/2 BSPT	S22	BTS 10 R1/2W	15	30.1	27.2	MCS 10 R1/2W	15	31.5	S22	MES 10 R1/2W	15	30	30.5
12	1/4 BSPT	S14	BTS 12 R1/4W	11.5	32.2	31.9	MCS 12 R1/4W	11.5	40.2	S22	MES 12 R1/4W	11.5	32.5	32.2
12	3/8 BSPT	S18	BTS 12 R3/8W	12.5	29.8	31.9	MCS 12 R3/8W	12.5	36.7	S22	MES 12 R3/8W	12.5	29.6	32.2
12	1/2 BSPT	S22	BTS 12 R1/2W	15	32.3	31.9	MCS 12 R1/2W	15	33.7	S22	MES 12 R1/2W	15	32.6	32.2

Units in mm



Ordering Part No. =  
(e.g., **MCC 10 R1/8**)

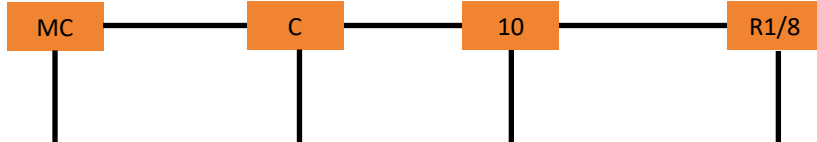

Fitting Name	
Back Ferrule	<b>BF</b>
Branch Tee	<b>BT</b>
Bulkhead Union	<b>BU</b>
Butt Weld	<b>BW</b>
Cap	<b>CP</b>
Cross Union	<b>CU</b>
Elbow Union	<b>EU</b>
Female Branch Tee	<b>FB</b>
Female Connector	<b>FC</b>
Front Ferrule	<b>FF</b>
Male Connector	<b>MC</b>
Male Elbow	<b>ME</b>
Nut	<b>NT</b>
Plug	<b>PG</b>
Reducing Union	<b>RU</b>
Run Tee	<b>RT</b>
Straight Union	<b>SU</b>
Tube Stem Reducer	<b>TRC</b>
Tee Union	<b>TU</b>

Material / Type	
316 Stainless Steel Double Ferrule Compression Fittings	<b>C</b>
316 Stainless Steel Barb Compression Fittings	<b>A</b>

Tube OD	
Inches	1/16
	1/8
	1/4
	5/16
	3/8
	1/2
	5/8
	3/4
	1
	4
mm	6
	8
	10
	12
	14
	16
	18
	20

Thread Size / Stem / Tube	
N = NPT	N1/8
	N1/4
	N3/8
	N1/2
	N3/4
	N1
	R1/8
R = PT (British Standard Pipe Taper Thread)	R1/4
	R3/8
	R1/2
	R3/4
	R1
Machine Thread	10-32
	M5
	M6

Features
316 Stainless Steel Compression Fittings with Double Ferrules, Compatible with Swagelok®, Parker-A-Lok, Let-Lok, Yor-Lok

## Compression Fittings Specifications

Specifications	
Operating Temperature	-425 to 600 °F
Material of Construction	316 stainless steel
Compatible with	Swagelok®, Parker A-Lok, Let-Lock, Yor-Lok
Service	Air, Water, Steam, Oil, Gasoline, Natural Gas, most solvents and acids that are compatible with 316 SS







Pressure		
Tube Size (OD)	Maximum Pressure (PSI @72 °F)*	
1/16"		10000
1/8"	2 mm	8800
3/16"	4 mm	5500
1/4"	6 mm	4200
5/16"	8 mm	3300
3/8"	10 mm	2800
1/2"	12 mm	2500
5/8"	16 mm	2300
3/4"	18 mm	2100
1"	20 mm	1900

\* Maximum pressures are based on Type 304 and 316 annealed stainless steel welded tubing made to ASTM A213, A249, or A269 standards.

# Compression Fittings List Price

Compression Fittings													
Model		Branch Tee		Female Connector		Female Branch Tee		Male Connector		Male Elbow		Run Tee	
		BTC		FCC		FBC		MCC		MEC		RTC	
Tube OD	Thread	Part No.	Unit Price	Part No.	Unit Price	Part No.	Unit Price	Part No.	Unit Price	Part No.	Unit Price	Part No.	Unit Price
1/8"	NPT1/8"	BTC 1/8 N1/8	\$23.27	FCC 1/8 N1/8	\$12.09	FBC 1/8 N1/8	\$30.40	MCC 1/8 N1/8	\$7.84	MEC 1/8 N1/8	\$12.95	RTC 1/8 N1/8	\$23.60
1/8"	NPT1/4"	BTC 1/8 N1/4	\$26.36	FCC 1/8 N1/4	\$12.09	FBC 1/8 N1/4	\$30.40	MCC 1/8 N1/4	\$8.62	MEC 1/8 N1/4	\$12.95	RTC 1/8 N1/4	\$30.80
3/16"	NPT1/8"							MCC 3/16 N1/8	\$7.26				
1/4"	NPT1/8"	BTC 1/4 N1/8	\$23.27	FCC 1/4 N1/8	\$8.79	FBC 1/4 N1/8	\$31.85	MCC 1/4 N1/8	\$6.78	MEC 1/4 N1/8	\$18.10	RTC 1/4 N1/8	\$22.35
1/4"	NPT1/4"	BTC 1/4 N1/4	\$26.46	FCC 1/4 N1/4	\$10.77	FBC 1/4 N1/4	\$31.85	MCC 1/4 N1/4	\$7.04	MEC 1/4 N1/4	\$12.13	RTC 1/4 N1/4	\$26.46
1/4"	NPT3/8"			FCC 1/4 N3/8	\$13.78	FBC 1/4 N3/8	\$37.97	MCC 1/4 N3/8	\$8.65	MEC 1/4 N3/8	\$18.10	RTC 1/4 N3/8	\$30.80
1/4"	NPT1/2"			FCC 1/4 N1/2	\$16.99								
5/16"	NPT1/8"	BTC 5/16 N1/8	\$27.38	FCC 5/16 N1/8	\$11.24			MCC 5/16 N1/8	\$9.98	MEC 5/16 N1/8	\$18.10		
5/16"	NPT1/4"	BTC 5/16 N1/4	\$29.20	FCC 5/16 N1/4	\$11.87			MCC 5/16 N1/4	\$9.98	MEC 5/16 N1/4	\$18.10		
5/16"	NPT3/8"	BTC 5/16 N3/8	\$33.19										
3/8"	NPT1/8"			FCC 3/8 N1/8	\$11.74			MCC 3/8 N1/8	\$12.45	MEC 3/8 N1/8	\$22.28		
3/8"	NPT1/4"	BTC 3/8 N1/4	\$33.19	FCC 3/8 N1/4	\$11.74			MCC 3/8 N1/4	\$14.37	MEC 3/8 N1/4	\$22.28	RTC 3/8 N1/4	\$28.09
3/8"	NPT3/8"	BTC 3/8 N3/8	\$33.19	FCC 3/8 N3/8	\$14.87			MCC 3/8 N3/8	\$12.45	MEC 3/8 N3/8	\$30.79	RTC 3/8 N3/8	\$32.54
3/8"	NPT1/2"			FCC 3/8 N1/2	\$19.69			MCC 3/8 N1/2	\$16.68	MEC 3/8 N1/2	\$30.79		
1/2"	NPT1/4"	BTC 1/2 N1/4	\$42.18	FCC 1/2 N1/4	\$21.40	FBC 1/2 N1/4	\$66.05	MCC 1/2 N1/4	\$13.14	MEC 1/2 N1/4	\$24.19		
1/2"	NPT3/8"	BTC 1/2 N3/8	\$42.18	FCC 1/2 N3/8	\$21.40	FBC 1/2 N3/8	\$66.05	MCC 1/2 N3/8	\$13.64	MEC 1/2 N3/8	\$24.19	RTC 1/2 N3/8	\$42.13
1/2"	NPT1/2"	BTC 1/2 N1/2	\$44.33	FCC 1/2 N1/2	\$21.40	FBC 1/2 N1/2	\$66.05	MCC 1/2 N1/2	\$14.61	MEC 1/2 N1/2	\$26.81	RTC 1/2 N1/2	\$44.33
1/2"	NPT3/4"							MCC 1/2 N3/4	\$19.63	MEC 1/2 N3/4	\$39.23		





4mm	M5							MCC 4 M5	\$12.45				
4mm	R1/8							MCC 4 R1/8	\$9.08				
6mm	M5							MCC 6 M5	\$9.08	MEC 6 M5	\$18.07		
6mm	R1/8							MCC 6 R1/8	\$9.08	MEC 6 R1/8	\$14.91		
6mm	R1/4	BTC 6 R1/4	\$26.46					MCC 6 R1/4	\$9.08	MEC 6 R1/4	\$14.91		
6mm	R3/8	BTC 6 R3/8	\$26.46										
8mm	R1/8	BTC 8 R1/8	\$34.14					MCC 8 R1/8	\$9.08	MEC 8 R1/8	\$16.72		
8mm	R1/4	BTC 8 R1/4	\$34.14					MCC 8 R1/4	\$10.18	MEC 8 R1/4	\$16.72		
8mm	R3/8							MCC 8 R3/8	\$11.48	MEC 8 R3/8	\$24.19		
8mm	R1/2									MEC 8 R1/2	\$24.19		
10mm	R1/8							MCC 10 R1/8	\$8.02				
10mm	R1/4							MCC 10 R1/4	\$8.02	MEC 10 R1/4	\$17.67		
10mm	R3/8							MCC 10 R3/8	\$10.19	MEC 10 R3/8	\$17.67		
10mm	R1/2							MCC 10 R1/2	\$16.68				
12mm	R1/4	BTC 12 R1/4	\$44.47					MCC 12 R1/4	\$20.29	MEC 12 N1/4	\$28.07		
12mm	R3/8	BTC 12 R1/2	\$44.47					MCC 12 R3/8	\$20.29	MEC 12 R3/8	\$28.07		
12mm	R1/2	BTC 12 R3/8	\$44.47					MCC 12 R1/2	\$21.77	MEC 12 R1/2	\$28.07		





Compression Fittings												
	Bulkhead Union <b>BUC</b>		Elbow Union <b>EUC</b>		Straight Union <b>SUC</b>		Tee Union <b>TUC</b>		Cross Union <b>CUC</b>		Reducing Union <b>RUC</b>	
Model	Part No.	Unit Price	Part No.	Unit Price	Part No.	Unit Price	Part No.	Unit Price	Part No.	Unit Price	Part No.	Unit Price
Tube OD												
1/8"	BUC 1/8	\$21.44	EUC 1/8	\$19.21	SUC 1/8	\$12.00	TUC 1/8	\$23.24	CUC 1/8	\$48.03	RUC 1/8-1/16	\$15.65
1/4"	BUC 1/4	\$20.56	EUC 1/4	\$18.43	SUC 1/4	\$12.00	TUC 1/4	\$25.11	CUC 1/4	\$43.77	RUC 1/4-1/8	\$12.38
5/16"	BUC 5/16	\$20.56	EUC 5/16	\$18.43	SUC 5/16	\$12.00	TUC 5/16	\$26.55	CUC 5/16	\$43.77	RUC 5/16-1/4	\$12.38
3/8"	BUC 3/8	\$29.85	EUC 3/8	\$17.54	SUC 3/8	\$14.00	TUC 3/8	\$26.55	CUC 3/8	\$55.02	RUC 3/8-1/8	\$18.98
3/8"											RUC 3/8-1/4	\$18.98
1/2"	BUC 1/2	\$31.79	EUC 1/2	\$28.97	SUC 1/2	\$21.22	TUC 1/2	\$38.79	CUC 1/2	\$57.09	RUC 1/2-3/8	\$22.66

4 mm					SUC 4	\$12.00						
6 mm	BUC 6	\$21.44	EUC 6	\$14.74	SUC 6	\$12.00	TUC 6	\$23.24				
8 mm					SUC 8	\$12.00	TUC 8	\$25.11				
10 mm			EUC 10	\$18.43	SUC 10	\$17.63						
12 mm			EUC 12	\$31.83	SUC 12	\$21.22						

Compression Fittings														
	Cap <b>CPC</b>		Back Ferrule <b>BFC</b>		Front Ferrule <b>FFC</b>		Nut <b>NTC</b>		Plug <b>PGC</b>		Tube Stem Reducer <b>TRC</b>		Tube X Male Pipe (Butt Weld) <b>BWC</b>	
Model	Part No.	Unit Price	Part No.	Unit Price	Part No.	Unit Price	Part No.	Unit Price	Part No.	Unit Price	Part No.	Unit Price	Part No.	Unit Price
Tube OD														
1/8"	CPC 1/8	\$7.02	BFC 1/8	\$1.34	FFC 1/8	\$2.31	NTC 1/8	\$2.31	PGC 1/8	\$6.94	TRC 1/8X1/16	\$14.75	BWC 1/8X1/8	\$7.30
1/4"	CPC 1/4	\$5.94	BFC 1/4	\$1.10	FFC 1/4	\$2.09	NTC 1/4	\$2.09	PGC 1/4	\$5.34	TRC 1/8X1/8	\$9.84	BWC 1/4X1/8	\$7.10
5/16"	CPC 5/16	\$6.33	BFC 5/16	\$1.39	FFC 5/16	\$3.54	NTC 5/16	\$3.54	PGC 5/16	\$6.18	TRC 1/8X1/4	\$9.76	BWC 1/4X1/4	\$7.44
3/8"	CPC 3/8	\$7.92	BFC 3/8	\$1.35	FFC 3/8	\$2.84	NTC 3/8	\$2.84	PGC 3/8	\$6.26	TRC 1/4X1/8	\$10.95	BWC 5/16X1/4	\$11.67
1/2"	CPC 1/2	\$11.90	BFC 1/2	\$1.90	FFC 1/2	\$4.63	NTC 1/2	\$4.63	PGC 1/2	\$8.92	TRC 1/4X1/4	\$7.65	BWC 3/8X1/4	\$11.65
											TRC 1/4X3/8	\$8.79	BWC 3/8X3/8	\$11.92
4 mm			BFC 4	\$1.94	FFC 4	\$2.09	NTC 4	\$2.09			TRC 1/4X1/2	\$10.33	BWC 3/8X1/2	\$16.40
6 mm			BFC 6	\$1.59	FFC 6	\$2.09	NTC 6	\$2.09	PGC 6	\$5.34	TRC 5/16X1/4	\$12.31	BWC 1/2X1/2	\$16.10
8 mm			BFC 8	\$1.95	FFC 8	\$3.54	NTC 8	\$3.54			TRC 3/8X1/4	\$10.90		
10 mm			BFC 10	\$1.35	FFC 10	\$4.63	NTC 10	\$4.63			TRC 3/8X3/8	\$10.61		
12 mm			BFC 12	\$2.78	FFC 12	\$4.63	NTC 12	\$4.63			TRC 3/8X1/2	\$10.90		
											TRC 1/2X1/2	\$13.34		

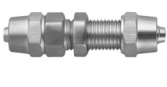
# Barb Compression Fittings List Price & Specifications

Barb Compression Fittings									
Model		Male Branch Tee Swivel		Female Connector		Male Connector		Male Elbow Swivel Connector	
		BTA		FCA		MCA		MEA	
Tube OD	Thread	Part No.	Unit Price	Part No.	Unit Price	Part No.	Unit Price	Part No.	Unit Price
1/8"	N1/8								
1/8"	N1/4								
5/32"	N1/8								
5/32"	N1/4								
1/4"	N1/8	BTA 1/4 N1/8	\$30.48	FCA 1/4 N1/8	\$20.21	MCA 1/4 N1/8	\$14.70	MEA 1/4 N1/8	\$27.19
1/4"	N1/4	BTA 1/4 N1/4	\$30.48	FCA 1/4 N1/4	\$20.21	MCA 1/4 N1/4	\$14.70	MEA 1/4 N1/4	\$27.19
5/16"	N1/8								
5/16"	N1/4								
5/16"	N3/8								
3/8"	N1/4					MCA 3/8 N1/4	\$14.70		
3/8"	N3/8								
3/8"	N1/2								
1/2"	N1/4								
1/2"	N3/8								
1/2"	N1/2								

Barb Compression Fittings											
Model		Bulkhead Union		Elbow Union		Plug		Straight Union		Tee Union	
		BUA		EUA		PGA		SUA		TUA	
Tube OD		Part No.	Unit Price	Part No.	Unit Price	Part No.	Unit Price	Part No.	Unit Price	Part No.	Unit Price
1/8"											
5/32"											
1/4"		BUA 1/4	\$31.10	EUA 1/4	\$31.10	PGA 1/4	\$5.99	SUA 1/4	\$18.61	TUA 1/4	\$31.10
5/16"											
3/8"											
1/2"											

## Barb Compression Fittings Specifications

Specifications	
Operating Temperature	-60 to 200°F (when used with Nylon Tubing) -350 to 500°F (when used with Teflon Tubing)
Material of Construction	316 stainless steel
Service	Air, Water, Steam, Oil, Gasoline, Natural Gas, most solvents and acids that are compatible with 316 stainless steel and the tubing material used
Maximum Pressure	800PSI @72 °F*

\* Maximum pressures are based on high pressure Teflon or Nylon tubing.